

# **Monte Carlo Electric Bike**

*User Manual*



 **DAYMAK**

# ***About Daymak***

Daymak is one of Canada's largest Alternative Vehicle providers. We design, engineer, manufacture, import and repair everything from recreational dirt bikes, go-karts and electric golf cars to alternative transportation solutions such as e-bikes and gas scooters.

Our electric bicycles represent an energy-efficient and eco-friendly alternative for people who need to get around the city. They greatly increase the practicality of bicycle transportation in urban centres. Costing only a few cents to charge, an e-bike can make city life more convenient and much less expensive.

While there are many new Green technologies that are still in their infancy, electric bicycles have been developing over the last 40 years or more. E-bike technology has been dramatically refined since the introduction of the first custom-conversion bicycles. Today, electric bicycles are a supremely reliable and affordable means of transportation.

Daymak is constantly developing new eco-friendly alternative transportation strategies, led by its own Research and Development department in Toronto, Canada. We are always improving our products. Our innovative in-house engineering and quality testing provide customers with many new kinds of reliable, eco-friendly vehicles, designed to help change the lives of our customers and the world.

Daymak warranties, services, and stocks parts for everything it sells. We support our products.

Please feel free to visit our website. You'll find the latest in cool transportation solutions, support for the products you've purchased and contact information.



# ***Table of Contents***

Introduction.....	4
Bicycle Part Diagrams .....	5
Riding Instructions .....	6
Operating Instructions .....	10
The Battery .....	12
Technical Data .....	17
Maintenance and Troubleshooting .....	20
E-Bikes and Canadian Law .....	25
TPS Training Bulletin.....	27



# ***Introduction***

## ***E-Bikes***

Riding an electric bicycle is a great way to hop around town conveniently and cheaply. E-Bikes represent a natural progression in the development of urban transportation.

Using only small amounts of electricity, e-bikes have the potential to radically reduce the amount of pollution in our cities. As well, they are very quiet, so they do not add to the high levels of noise pollution which we often take for granted. They are easy, and usually free, to park. They are unobtrusive and highly practical additions to the urban landscape.

E-bikes are also inexpensive. They (currently) require no registration, no insurance, no licence and do not incur parking charges. As well, compared to internal combustion engines, the engines in electric vehicles have fewer moving parts and require far less maintenance.

Your Daymak e-bike is the result of Daymak's years of experience, the highly trained technical skills of our staff and careful, ongoing design work by our engineers. We hope you enjoy using this product and welcome any feedback that you may have.

## ***New Laws***

Most provinces in Canada, most states in the U.S.A, the United Kingdom and many European countries have new laws that permit cyclists to use electric motors to assist the regular operation of bicycles. Please check with your provincial or state government to learn about your local laws. At the back of this manual you will find the some of the common Canadian provincial regulations that govern e-bikes.

## ***Liability***

Daymak does not assume any liability for damages, loss of profits, or claims from third parties due to improper use of this product. Daymak does not assume any liability for damages due to problems with the product resulting from service by a third party that is not certified by Daymak.

The information in this guide may be subject to change without notice. For the latest information available, please contact your local Daymak dealer or visit our website.

We have taken all possible measures to ensure the accuracy and completeness of the information in this guide. However, if you do find anything missing, incomplete or wrong, do not hesitate to contact us.



# Bicycle Part Diagrams

## Diagram 1: The Monte Carlo Electric Bicycle

This diagram illustrates the various parts of your bicycle. Please note that many of these parts are not user-serviceable and should be repaired only by trained professionals. This is especially true of the electrical systems and the mechanical components.



- |                          |                                 |                         |
|--------------------------|---------------------------------|-------------------------|
| 1. Seat                  | 8. Controller (inside)          | 15. Tire                |
| 2. Rear Compartment      | 9. Kickstand                    | 16. Front Mud Guard     |
| 3. Taillight             | 10. Battery (inside)            | 17. Headlight           |
| 4. Rear Mudguard/Fairing | 11. Battery Carrier (with lock) | 18. On / Off key switch |
| 5. Rear Wheel            | 12. Battery charger slot        | 19. Handlebars          |
| 6. Rear Shock Absorber   | 13. Front Shock Absorber        | 20. Foot Pegs           |
| 7. Hub Motor             | 14. Wheel Rims                  | 21. Seat Compartment    |

## Diagram 2: The Handlebars and Controls

This diagram illustrates the various parts of your bicycle. Please note that many of these parts are not user-serviceable and should be repaired only by trained professionals. This is especially true of the electrical systems and the mechanical components.

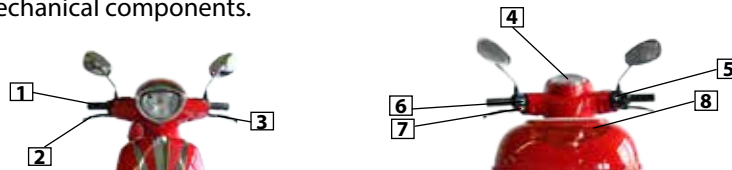

- |                           |                                |             |
|---------------------------|--------------------------------|-------------|
| 1. Accelerator            | 4. Speedometer                 | 7. Horn     |
| 2. Front brake controller | 5. Turn signals                | 8. Ignition |
| 3. Rear brake controller  | 6. Headlight/Tail light switch |             |

 **DAYMAK**

# ***Riding Instructions***

This guide assumes that you already know how to ride a standard bicycle. Before you try to ride an electric bicycle, you should be very familiar with controlling and balancing a normal bicycle.

## ***Caution***

If you do not have cycling experience, an e-bike is too dangerous to ride. Do not begin learning to ride a bicycle using an e-bike.

## ***Important Notes***

- **Ebikes are Fast!** E-bikes are capable of traveling at higher speeds than many bicycle riders are accustomed to. Use caution at all times, especially when travelling in mixed traffic. Always take into account driving and traveling conditions.
- **Obey the Law.** Be sure to follow all provincial and city traffic laws. This includes obeying stop signs, checking carefully when turning, and riding defensively. An e-bike is a motorized vehicle, even though it is classed as a bicycle. You must follow the law.
- **Stay Sober.** Never ride your bicycle while intoxicated. An e-bike is capable of traveling faster than a normal bicycle, and you should always be in control of it.
- **Share the Road.** Be careful in mixed traffic. When on bicycle paths, traveling near pedestrians, or on recreational trails, try to be polite and courteous to those using the paths with you. E-bikes are new in most cities, so other users of the roads and recreational paths may not know how to deal with e-bike riders. Bear in mind that, in a sense, e-bike riders are “ambassadors” for this new method of transportation.

## ***Items to Carry with the Electric Bike***

It is a good idea to carry the following items with you at all times when you ride your e-bike.

- The charger, to charge the bike in case the battery power runs out
- 30 Amp Fuse, spares for the batteries, in case the fuses blow
- A lock, to secure your e-bike when you park it
- A helmet, as required by safety laws



## ***Inspecting your Electric Bike***

Always inspect your e-bike before you ride it, to make sure its safety features are operating properly. Many accidents can be avoided with routine inspections. Once you are comfortable with your e-bike, you will be able to detect small changes in the way it feels. If anything changes between uses, make sure to have it properly examined. Also, be sure to listen for changes in the sounds your e-bike makes over time. Any mechanical or power issues may have effects on the sounds the bicycle makes.

## ***Holding the Handlebars***

As with a normal bicycle or gas scooter, place your fingers over the brake levers, using the palms of your hand and your thumbs to wrap around and under the handlegrips. Doing this allows you to activate the brakes easily, by squeezing your hand, in case you have to stop quickly. This is the safe way to control your electric bicycle.

## ***Turning your E-bike On and Off***

To turn on your e-bike, insert the key into the “ignition”, located just below the dash board, and turn the key to the right. When your e-bike is activated, the power indicator will light and the battery charge indicator will jump, showing you how much power your e-bike has. To turn off the e-bike, simply turn the key to the left, and remove the key.

### ***Warning***

When you activate the e-bike, the electrical system becomes live. Do not try to affect changes to the E-Bike (such as removing the battery or repairing electrical components) while the E-Bike is activated. Turn the E-Bike off and remove the key before you attempt to access any of the electrical components. Also, the battery carries a significant electric charge and can injure people if not treated properly and with respect.

## ***Accelerating and Decelerating***

The throttle is found on the right-side hand grip on the handlebars. Turn the grip forward (away from you) to accelerate. To decelerate, release the grip (turn it towards you). Don't over-rotate the accelerator, as this could damage the battery and electrical components.

### ***Warning***

Do not activate the accelerator until you are seated on the bicycle and are ready to accelerate. The e-bike can easily escape from your control, possibly injuring you or others, and the e-bike may be damaged by being dropped.



## ***Stopping***

Your e-bike has two sets of brakes, at the front and at the rear. The levers attached to the handlebars, on the left and right, activate the brakes. Pull the levers toward you to activate the brakes.

You can use both brakes to come to a stop more quickly, or you can use one of the brakes to come to a gentle stop, depending on your riding needs at the moment.

When the brakes are activated, the power to the engine is automatically turned off, until you release the brakes. This allows you to stop safely.

## ***Safety Tips***

- When you are traveling in wet weather, water may cause your brakes to function less efficiently because it reduces friction between the brake pads and the wheels. Take care to slow down and give yourself more room to stop or slow if necessary.
- It is a good idea to have your brakes and brake pads checked regularly. The brake pads will eventually wear down through friction, and after significant use will have to be replaced.

## ***Signalling***

### ***The Horn***

The e-bike has a horn. The horn button is on the left handlebar. Simply press it to activate the horn.

### ***Turning Signal Lights***

Your e-bike has turn signal lights. The turn signal activator is on the left handlebar. Push it left or right to activate it to indicate that you are turning in the appropriate direction, and press the middle of the button to turn it off. The turn signals also emit a noise, to ensure that everyone knows you are turning. This turn signal cannot be disabled without also disabling the visual signal.

### ***Lights***

The headlight and taillight are useful features when you are riding at night or in dark areas. They radically improve your safety in mixed traffic. The switch is located on the left handlebar. The lights on your e-bike consume some electricity. Keeping them on may reduce the maximum distance you can travel on one charge by about 5 %.





## ***Pedaling***

This e-bike is designed to be a motor-assisted bicycle. You can use the motor by itself, but ideally, you can work with the motor by pedaling. This increases the distance you can travel on your e-bike, because it assists the motor and reduces the amount of electricity you draw from the battery.

## ***Riding in Wet Weather***

Your e-bike is designed to function in wet conditions, such as when it is raining. However, because the motor is on the rear wheel, it is easy to slip when moving at high speeds. If it is very wet, be sure to avoid high speeds.

When you are traveling in wet weather, water may cause your brakes to function less efficiently because it reduces friction between the brake pads and the wheels. Take care to slow down and give yourself more room to stop or slow if necessary.

## ***The Motor and Water***

Your e-bike is not designed to be immersed in water. Always ensure that the water level does not go above the middle of the tire, to prevent water from getting inside the motor.

Water in the motor can cause short-circuits and may damage the electrical systems in your e-bike.

## ***Riding in Cold Weather***

Your e-bike is designed to operate year-round. However, in very cold conditions or when there is a lot of snow or slush on the ground, it is possible for the motor in the e-bike to get wet or for the brakes to function less efficiently, just as can happen in wet weather. Below 10 degrees Celsius, the battery will not work as well as it would in warmer temperatures. While Lithium-Ion batteries perform better than Lead-Acid batteries in temperature extremes, both will experience reduced performance in cold temperatures.

Also, riding the e-bike in cold temperatures may require you to replace the battery sooner rather than later.



# ***Operating Instructions***

## ***Using the Rear Storage Compartment***

The rear storage compartment is opened using the key provided to you when you purchased your e-bike. Insert the key and turn it to the right to open the compartment. Close the case and turn the key in the opposite direction to lock the compartment again. You can use this compartment to store the charger and associated cables, so you can recharge your e-bike if it runs out of power. It can also hold a locking mechanism, such as a u-lock, for added security when parking your e-bike. The space provided is perfectly suited for these purposes.

## ***Opening the Seat Trunk***

To open the seat trunk, insert the key into the lock on the left side of the e-bike just below the seat. Turn it all the way to the right. The seat will snap open and pop up.

To close the seat trunk, make sure that there is nothing blocking the locking mechanism, such as items you have placed in the storage compartment, and push the seat down with force. You will hear a “click” sound when it is properly closed.

## ***Parking and Locking your E-bike***

When you want to park your e-bike for a short time, either when you have reached your destination or are at home, follow these steps:

- 1.** Stop the e-bike and position it as you want it.
- 2.** Get off the e-bike, making sure to keep it balanced.
- 3.** Stand to the side and slightly to the rear of the e-bike.
- 4.** Hold the kickstand with one foot, and hold on to the e-bike by the rear basket bracket. This bracket is made of metal and will hold the e-bike’s weight.
- 5.** Pull the back of the seat up and towards you. The e-bike will move backwards. The kickstand will hold the e-bike in place and anchor the bike.
- 6.** Lock your e-bike to a bicycle locking post or other secure object through the rear wheel frame or one of the metal frame components.

### ***Warning***

Do not let your e-bike drop or fall. The exterior may be damaged. The fall may damage other components inside the e-bike, as well.



## ***Maximum Load***

Do not exceed the maximum load capabilities of your e-bike. You can find the exact loading capacity listed in the technical specifications in this guide.

If you exceed the maximum load, the performance of the bike will suffer.

Exceeding the maximum load of your e-bike could cause damage to the shocks, to the mechanism and, ultimately, even to the frame. It could also cause your motor to work too aggressively, and it may burn out.

## ***Disconnecting the Circuit Breaker***

When the circuit breaker is disconnected, all power from the battery to the e-bike is blocked. This is useful if you are going to store your e-bike or if it is damaged and you wish to bring it to be serviced.

Disable the circuit breaker using the following very simple procedure.

1. Open the seat compartment.
2. Find the circuit breaker switch (it should be very obvious).
3. Activate the switch. The power to the e-bike will be disabled.

## ***Long-Term Storage of your E-bike***

If you are storing your bike for a long period, disconnect the circuit breaker. This is a safer way to store the electric bicycle, as it prevents accidental activation of the e-bike and makes it impossible to activate it even with the key. The circuit breaker is found by opening up the battery case. It sits between the battery and the controller.

Please see the section titled "Your Battery" for instructions on battery maintenance while your e-bike is being stored.



# *The Battery*

This section details what you need to know about the battery that powers your e-bike. Always remember to treat your e-bike's electrical systems with respect.

## *Battery Power*

The dashboard has a battery charge indicator. When the e-bike is activated, the needle will jump and indicate the currently available battery power.

If the power has dropped significantly, you should charge your e-bike.

## *Distance and Power*

Your battery has the capacity to carry you anywhere from 35 to 50 km before it must be recharged. The ability of your battery to power your bicycle depends on many variables. These variables include the weight of the rider, the prevailing wind resistance, the rider's driving habits, the presence of steep hills and inclines, and other issues such as proper air pressure in the tires.

## *Saving Power*

If you are traveling long distances, you can save a lot of electricity by using better driving habits:

- **Coasting:** When going downhill or over long, flat road surfaces, try using your e-bike's momentum and allow it to coast, without drawing power from the motor.
- **Stopping and Starting:** Try to avoid stop and go movements. The motor draws more power when starting from a full stop.
- **Weight:** Remove unnecessary weight from the bike. This reduces the amount of power the motor must draw.
- **Air Pressure:** Make sure your tires have the proper air pressure. Proper pressure reduces drag on the tires and radically increases the efficiency of any vehicle.
- **Head and Tail Lights:** Turn off the lights to conserve power, if it is safe to do so. The lights will reduce the distance you can travel by about 5%.
- **Peddaling:** When accelerating from a full stop, you might want to try pedaling to help acceleration



# Charging your E-Bike

Charging your e-bike is a simple process. You require the following:

- The charger that came with your e-bike.
- A 110V household electrical outlet.

## **Charger Warning**

Only use the chargers that were supplied with your e-bike. Using chargers that do not have specifications identical to those which came with the e-bike could irreparably damage your e-bike's battery and electrical systems, and may cause injury.

To charge your e-bike, follow these steps:

- 1.** Turn off the e-bike and remove the key from the "ignition."
- 2.** Plug the female end of the charger cable into the charging slot on the e-bike. This is found on the outside casing of the e-bike, in front of and just underneath the seat.
- 3.** Plug the male end of the charger power cable into your wall socket. This should be a 110v household electricity supply. You can also use a portable generator, if necessary, but make sure it provides 110V current.
- 4.** Allow the e-bike's battery to charge for the appropriate amount of time (6-12 hours).
- 5.** Disconnect the charger when the LED light on the charger is green. The batteries have been fully charged.

If your charger's LED status light does not change from red to green over an extended period of time, for perhaps more than 14 hours, and the battery is very hot, the battery or charger may need replacing. Stop charging and bring both to your Daymak dealer immediately. Do not charge the battery.



## **Battery Care**

Follow these suggestions to maintain your battery's optimal performance. If you do not follow these suggestions, your battery may lose its ability to maintain a charge and might have to be replaced sooner than would otherwise be necessary.

- **Charge it:** Charge your battery immediately after riding it.
- **Full Charge:** Do not allow the battery to run down completely and lie in storage without a charge. This significantly reduces the battery's lifespan and may cause damage.
- **Keep it Charged:** When being stored, charge the battery occasionally to make sure its power supply does not run down. Charging it once every 21 days should be sufficient.
- **Storage Conditions:** Store the battery on a flat, cool, dry surface. Do not allow the battery temperature to drop below 10 degrees Celsius for extended periods of time.

### **Warning**

**DO NOT** place your Lead-Acid battery on concrete. Concrete drains the battery's power and will neutralize the lead-acid. Placing the battery on concrete for any length of time will likely result in the battery being drained of power and possibly losing its ability to store electricity.



## ***Cold Weather and your Battery***

Below 10 degrees Celsius, the battery will not work as well as it would in warmer temperatures. While Lithium-Ion batteries perform better than Lead-Acid batteries in temperature extremes, both will experience reduced performance in cold temperatures.

Also, repeatedly riding the e-bike in cold temperatures may cause your battery to have to be replaced sooner.

## ***Handling the Battery***

The battery contains large amounts of electrical power. You must use caution and respect when handling it. Not following these instructions can result in serious injury.

### ***Warning***

Follow these instructions closely. Use care when handling your battery.

- Always lift the battery with both hands, and carry it with care. Never drop the battery. If the case is damaged, the contents may leak out.
- Never puncture or open the battery case. The contents are dangerous and may cause injury. Do not touch the contents of a leaking battery. Seek help immediately.
- Do not touch the two metal poles on the battery box at the same time. This can cause a short-circuit. It could injure you or others and cause serious damage to the electrical systems in the e-bike. Your battery contains significant amounts of electrical power.
- Do not handle your battery if either you or the battery are wet. Water is an excellent conductor of electricity. You may experience an electrical shock, and you may be injured.



## ***Replacement and Disposal***

After approximately 300 charges, a lead-acid battery will need to be replaced. A lithium-ion battery will last approximately 1500 charges. When the battery has to be replaced, you will notice that your battery cannot carry as much of a charge as it could initially.

Contact your local Daymak dealer to purchase a new battery.

When replacing your battery, dispose of it at a proper municipal battery recycling facility. If none is available, please contact your local Daymak dealer.

### ***Warning***

Be absolutely sure that you replace the battery with an identical or very similar battery. While it is possible to change the battery format or power levels, this requires advanced knowledge of electrical systems. If improperly done, this can result in immediate and irreparable damage to the electronic controller and electrical systems. Be absolutely certain of what you are doing before you replace the battery with a different type of battery.

Using the wrong type of battery will also void your warranty.





# ***Technical Data***

This section provides you with the technical specifications for your e-bike.

## ***The Motor and Wheel Assembly***

The Smart Bike has a 500 Watt magnetic DC brushless motor on the rear wheel hub. This type of motor has excellent low-end torque and high efficiency when working within its range. Note that while the motor is very quiet, it does produce some noise. Also attached to the rear hub are speed reduction gear and the speed free clutch.

## ***The Freewheel***

The wheels have freewheels, so the e-bike's drive train is not fixedly geared. This means that when coasting or traveling downhill, you can turn off the engine and your e-bike will continue to move without slowing. This feature will allow you to achieve faster speeds when coasting, moving downhill or moving with the wind. It will also allow you to conserve electrical power, because you will be able to let the motor rest while moving.

## ***The Controller***

Daymak pioneered the development of intelligent component control in e-bikes. The "D- Drive" technology developed by Daymak is the brain of your e-bike. It allows your e-bike to achieve faster acceleration, to climb steeper hills, and to save energy. In future, it will allow for other ways of recharging your e-bike's batteries, such as by using solar or wind power.

The electronic controller is located under the seat assembly. This controller efficiently regulates the speed and electronic functions of the bicycle. It allows for stepless speed adjustment, shuts off the motor when the brakes are activated, has low voltage protection and has fuses to prevent excess current from damaging the e-bike's systems.

## ***The Governor***

A key component of the controller is the Governor. The Governor regulates the speed of the e-bike. It prevents the motor from assisting riders when the e-bike's speed surpasses 32 km per hour.

The governor's primary function is to make sure that the motor functions efficiently. If the governor is not functioning, the mileage of the e-bike will be dramatically reduced, and its performance will suffer.

Disabling the governor voids the warranty, and may damage your controller.

This speed limitation to 32 km per hour is required by government regulations. Traveling faster than 32 km per hour through motor power alone is illegal in Canada and could result in serious fines or penalties, unless your vehicle is insured for liability, is registered and you are licensed to drive.



## ***The Brakes***

### ***Front Brakes***

The brakes on your e-bike are drum-brakes, like those found on gas scooters and motorcycles. They generally provide for very fine stopping and control. This is a very tested and well-designed technology, but even so, the brakes will require servicing from time to time, and may have to be adjusted for tension.

Unlike normal friction-grip bicycle brakes, which clamp down from the outside, the drum brakes clamp from the inside. When the brakes are activated, tension increases and the clamps engage. This is a very effective and reliable way to stop a vehicle.

The brakes are contained within a sealed unit, and are very finely adjusted and fitted.

### ***Rear Brakes***

The rear brakes on your e-bike are EABS Brakes (Electric Absorption Braking System). These provide a good friction-grip when they are activated. They significantly less than standard drum brakes. Using these brakes helps to reduce the weight of the e-bike and improve its performance.

## ***The Chain and Pedals***

The pedals are connected to the rear wheel. Along with the chain, they provide a human- powered “drive train”. This is an important part of your e-bike. The pedals are not removable and should not be removed.

## ***Shock Absorbers***

Your Monaco e-bike is equipped with Reverse Shock System shock absorbers. These effective but simple devices absorb the energy from bumps and dips, and allow you to have a much more comfortable ride. The Reverse Shock System is superior to normal Monoshock shock absorbers usually found on e-bikes, and provides for a much more comfortable ride.

While they are very resilient, please note that very sharp or large shocks, such as drops from a height of 15 cm or more, can cause serious damage to your shock absorbers. Replacing them is a complex and time-consuming task, so do be careful when dropping from larger heights.



## Basic Statistics

### Dimensions

Wheel Size: 3.0"x16"  
 Body Size: 187x52x115cm  
 Seat Height 75cm (29")

### Weight

65 kg without battery  
 80 kg with battery

### Loading Capacity

Standard: 75 kg  
 Maximum: 150 kg

### Speed and Mileage

Max. Speed: 32 km/h  
 Max. Mileage: 50 km

## Electrical System Statistics

### Motor Statistics

Rated Power: 500W  
 Voltage: 72V  
 Max. Climbing Angle: 15 degrees

### Charger Statistics

Charger Input: AC 100 – 240V  
 Standard Input voltage: 110V  
 +/- 10%

Output: DC 48V, BM-online  
 Charger output voltage: 43.8 +/- 10%, 50Hz

Power Rated: 80W  
 Voltage Charge: 43.2 – 44.2V  
 Charge Current: 2.5A +/- 0.02A  
 Charge Time: 6-12 hours

### Battery Statistics

Type: Sealed Lead Acid Battery  
 Voltage: 72V20AH  
 Battery Life: 300 charges

## Wiring Diagram

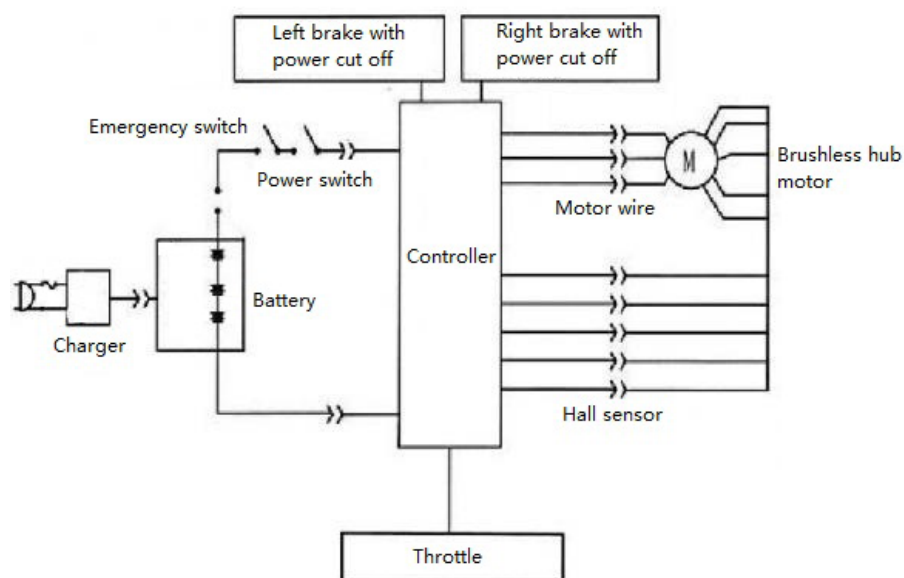

# ***Maintenance and Troubleshooting***

This section outlines problems you may have and solutions you may be able to use.

Many of the parts in this product are not user-serviceable and should be repaired by trained professionals. This is especially true of the electrical systems and the mechanical components. Alteration of these components voids the warranty.

## ***Tire Pressure***

Maintain the air pressure in your tires at the appropriate level. If the air pressure is too low, your e-bike's performance will suffer and it will become damaged more easily.

Cold weather and lower temperatures will cause the air pressure in your tires to drop, and warmer weather will cause it to increase, even if there are no leaks in the tire tube. To replace the air in your tires, follow this procedure:

1. Identify the required pressure by examining the text along the side of the tire rim. This text should indicate the recommended pressure for your tire.
2. Locate the air valve on the inner surface of the tire rim.
3. Remove the valve cap and place in a secure location.
4. Place the nozzle end of an air pump (hand-power or mechanical) over the valve.
5. Pump up the air in the tire, being careful not to let the pressure go above the level prescribed on the side of the tire wall.
6. Remove the pump nozzle from the air valve without allowing much air to escape from the tire.
7. Replace the valve cap on the air valve.

Maintaining the proper air pressure will allow you to travel much further on a single charge, because the motor will not have to work as hard to move the e-bike.

## ***Replacing Flat Tires***

Replacing flat tire tubes is a more complicated and labour-intensive process with e-bikes than it is with regular bicycles. It requires proper tools, more skill and more patience. The front wheel is easier to service when changing a flat tire than the rear wheel, as the rear wheel is connected to the hub motor and other mechanical parts.

Unless you are very familiar with the mechanical components of the rear motor, attempting to change a flat rear tire may cause serious problems. Please contact your Daymak dealer for specific instructions on how to remove your wheel and tires safely, and how to replace the tubes.

It may be easier – and safer - to have the tubes replaced by your Daymak dealer.



## ***The Brakes***

The drum brakes on your Smart Bike allow you to stop and are a critical safety feature. Make sure you test them regularly. Take the e-bike to your Daymak dealer if the brakes appear to be losing their stopping power or feel looser than they were previously.

The brakes on your e-bike may require servicing from time to time. The brake pads will need to be replaced as they wear down, usually after about a year to a year and a half or so, depending on how the e-bike is ridden. Also, the brake cables may have to be adjusted for tension.

You can only service the brakes yourself if you have extensive experience servicing drum brakes. Please do not attempt to service the drum brakes if you are not absolutely sure how to do it.

### ***Adjusting the Brake Cable Tension***

From time to time, you may need to adjust the brake cable tension, to loosen or tighten the drum brakes.

On your drum brakes, a small wing nut rides up and down a threaded bolt, moving the brake cable and tightening or loosening the brake pads.

Just outside the casing, near the drum brake, the brake cable joins the drum brake. A small wing nut allows you to adjust the tension.

1. Locate the wing nut on the drum brake.
2. To tighten the brakes, turn the wing nut clockwise.
3. To loosen the brakes, turn the wing nut counter-clockwise.
4. Adjust the tension until the drum brakes are tight enough to provide for proper safety but are loose enough to allow the wheel to move freely when the brake is not engaged.

### ***Warning***

Your brakes are a critical safety feature. Do not excessively loosen the drum brakes. If you do not keep them sufficiently tight, your drum brakes will fail and your e-bike will not be able to stop properly.



## ***The Motor***

Do not service the motor yourself. Bring the e-bike to your Daymak dealer for service. The motor in your e-bike is a highly complex and fine-tuned mechanism. Repairing it requires significant expertise.

We suggest maintenance every 100 running hours or so.

## ***The Chain***

Ensure that the chain on your e-bike is well-oiled and lubricated. It is an important part of your e-bike. As with any bicycle, it needs to be maintained if it is to function.

## ***Shock Absorbers and Comfort***

If your riding experience feels bumpier than usual, and you suspect that your shock absorbers are experiencing difficulties, check the air pressure in your tires. If the air pressure is too low, this may be the reason you feel less comfortable. It may have nothing to do with your shock absorbers.

If the problem persists, take your e-bike to your Daymak dealer for servicing.

## ***Bringing in your E-bike for Service***

Do not attempt to service the electronic or mechanical parts of your e-bike unless you are absolutely sure of what you are doing and have a solid understanding of electrical and mechanical equipment.

If your e-bike is not performing properly, disconnect the circuit breaker and bring the e-bike to your local Daymak dealer.

Do not store the e-bike without disconnecting the circuit breaker.

## ***Liability***

Daymak will not be held responsible for damage or injuries resulting from errors resulting from improperly serviced parts.



## ***Ebike Maintenance***

### ***Cleaning***

Cleaning is extremely important this will ensure your e-bike will serve you for a long time. In the long run, it will save you money and a lot of time waiting for the bike to be repaired. You should clean your ebike weekly.

Do not use aggressive power jets or water sprays when washing the ebike and keep water off the battery as much as you can. Clean gently but thoroughly and make sure that all the outer casing of the electric parts are dry and clean.

Remove any dirt, debris, sand, mud, grit, grime that got caught on the bike and dry it off. While cleaning, it is a good opportunity to look closely for a worn, loose, cracked, rust, teared or damaged parts. Buckled paint can also be a hint for some parts that need closer inspection.

### ***Lubricating***

It is also recommended to lubricate the chain, levers, derailleur, cables, etc. A clean, lubricated e-bike tends to be faster, smoother and quieter. It's like having a little extra push for free.

Apply the lubricant to the different parts and let it sit a few minutes and then wipe off the excess lubricant with a rag. After a while, clean the different parts with a degreaser to remove any excess dirt that has been collected.

### ***Weather***

Don't leave the bike out in the rain or snow.

Store it somewhere dry and out of direct sunlight. Overheating the batteries, for example, can cause problems.





Do not open up casings, chargers, etc as you are unlikely to be able to reseal them effectively afterward, making them more susceptible to water damage and other extreme weather conditions.

Batteries should be removed from the ebike if not used and charged once a month regardless of usage.



# Maintaining your Ebike

The frequency of maintenance depends on how much you ride and under which conditions. Recreational riders need far less maintenance than off-road riders. The harder you ride, the more you have to take care of your bike if you want it to last. There are various time intervals for proper maintenance. Quick maintenance should be done before & after every ride.

Time after purchase	Action Suggested
<p>Everytime before you ride The 60 second check</p>	<p>Check tire pressure, check brakes that they work, check lights, check bolts (make sure everything is tight), check battery gauge. Do not ride the ebike unless everything is functional and proper.</p> 
<p>30 days (every month)</p>	<p>Completely clean the bike, including the dust on the motor and under the seat. Check for any abnormal wear and tear or alignment problems.</p> 
<p>90 days (every 3 months)</p>	<p>Inspect frame and fork for paint cracks or bulges that may indicate frame or part damage; pay particular attention to all frame joints. Check wear and tear on tires. Check range of battery.</p> 
<p>180 days (every 6 months)</p>	<p>Inspect all components of the ebike. Check that connections are nice and tight. Look inside where you controller is and clean in detail. Check that all plugs. Go over every bolt and nut in your ebike.</p> 
<p>360 days (every 12 months)</p>	<p>Bring ebike for complete tune-up. Varying on the ebike the ebike shop should complete a battery discharge, tires should be changed depending on wear and tear. All connections should be checked for rust and looseness. All components should be checked including charger, ignition and gauges.</p> 





# ***Ebikes and Canadian Law***

***British Columbia, Alberta, Saskatchewan, Manitoba, Quebec, Nova Scotia, Newfoundland and Labrador, Yukon***

Currently, eight Canadian jurisdictions (British Columbia, Alberta, Saskatchewan, Manitoba, Quebec, Nova Scotia, Newfoundland and Labrador and Yukon Territory) have legalized power-assisted bicycles for public road use and are treating these vehicles as conventional bicycles and not as motor vehicles. As such, they do not require insurance, registration or licences. E-bike technical specifications must fall within certain parameters, however,

The rules are similar in every province, with minor variations, and are not considered controversial. Consult your local ministry or department of transportation for guidelines.

## ***New Ontario Regulations***

Ontario is currently running a pilot program to determine whether or not e-bikes should be allowed on Ontario roads and under what conditions. The pilot program ends in 2009, at which point decisions will be made as to the future of e-bikes on Ontario roads. Because the program in Ontario is new, and the rules are often unfamiliar even to law enforcement officials, we have included a synopsis of the regulations here. These rules are very similar to the rules currently in place in other Canadian provinces. Print the "TPS Training Bulletin" at the end of this manual and keep it with you when you are traveling. If you are stopped by traffic authorities who are unfamiliar with e-bikes or the regulations concerning them, show them this bulletin. They should allow you to continue.

## ***Definition of an E-bike***

An e-bike is a bicycle with an added battery powered electric motor that does not exceed 500 watts and can assist the cyclist up to a speed of 32 km/h. It can also be driven like a bicycle without any power assist. The addition of the power assist enables the rider to pedal with less effort, to achieve a greater distance, to climb hills and ride against the wind more easily. In its size, weight, speed and the driving skills required, the e-bike is similar to the conventional bicycle. A power-assisted bicycle is the same as an e-bike. An e-bike is considered a power-assisted bicycle as long as it meets all the requirements of the Motor Vehicle Safety Act.

## ***Traveling by E-bike***

Power-assisted bicycles will be able to travel anywhere a bicycle travels. They will be permitted on trails and paths where municipal by-laws permit bicycles. Power-assisted bicycles, like bicycles, are not allowed on controlled-access highways such as the 400 series highways, the Queen Elizabeth Way, the Queensway in Ottawa or the Kitchener- Waterloo Expressway, or on municipal roads, including sidewalks where bicycles are banned under municipal by-laws.

## ***Who Can Ride an E-bike***

Anyone who is 16 years of age or older and wears an approved bicycle helmet at all times while operating an e-bike can ride one.



## ***Specific Riding Requirements***

Power-assisted bicycles are treated as bicycles. This means:

- No driver's licence is required
- No written test is required
- No vehicle registration or license plate is required
- No motor vehicle liability insurance is required
- Operators must be 16 years of age and older
- All persons are required to wear an approved bicycle helmet
- Only electric bicycles that conform to the federal Motor Vehicle Safety Act regulations and are labelled as a "power-assisted bicycle" are eligible for the pilot program.

## ***Equipment***

A power-assisted bicycle (e-bike):

- Has steering handlebars and is equipped with pedals
- Is designed to be propelled primarily by muscular power and to travel on not more than three wheels
- Has a motor that has a power output rating of 500W or less. The motor is electric, and is incapable of propelling the cycle at speed of 32km/h or greater on level ground, without pedaling.
- It must bear label indicating that it is a "Power-Assisted Bicycle."

## ***Safety Equipment***

Power-assisted bicycles will require the same safety equipment as bicycles under the Highway Traffic Act:

- Proper lights
- Proper brakes
- Proper bell

## ***Bicycle Helmets***

Anyone operating an e-bike will be required to wear an approved bicycle helmet. There will be no age exemptions.

## ***Fines and Penalties***

All the set fines established for violating rules of the road and equipment standards that apply to bicyclists would apply to drivers of e-bikes. However, offences directly related to the pilot program (i.e.; riding an e-bike under the age of 16 or anyone riding an e-bike without a helmet) would be subject to the higher fines set for pilot projects, ranging from \$250 to \$2,500.

## ***Drinking and Driving***

Drinking and driving a motor vehicle is a Criminal Code offence and charges are laid under the Criminal Code of Canada. Under the Criminal Code, the definition of a "motor vehicle" would include an e-bike and anyone operating an e-bike intoxicated could be charged for impaired driving. If convicted, the offender would be subject to the Criminal Code penalties, including a fine or jail time, and a driving prohibition. However, under this pilot regulation, an e-bike would not be a motor vehicle under the Highway Traffic Act, so penalties for impaired driving under the Act would not apply.



# ***TPS Training Bulletin***

TPS Training Bulletin

Attention Traffic and Training Sergeants:

Recently we have had some enquiries from officers in the field and members of the public regarding e-bikes and have found that there is some confusion over the definition of a Power Assisted Bicycle (e-bike).

According to Ontario Regulation 473/06, an e-bike that meets the definition is deemed not to be a motor vehicle, under the Highway Traffic Act, and is essentially treated as a bicycle. Any person 16 years and over who wears a bicycle helmet as required by subsection 104 (2.1) of the HTA may ride a power assisted bicycle on the highway. There is no requirement for a drivers license, a permit or insurance.

The main requirements for a bicycle to be designated a “power assisted bicycle” is that it “is capable of being propelled by muscular power” and a “bears a label that is permanently affixed by the manufacturer stating that the vehicle is a power assisted bicycle”. Obviously while the e-bike is being operated on the road, the pedals must be attached and functional.

O. Reg 473 refers to federal Motor Vehicle Safety Regulations for a definition. Rick Line, TC 4365,

TPS Training & Education Unit, Traffic & Provincial Statutes Section, C.O. Bick College, 4620 Finch Ave. E., Scarborough, On, M1S-4G2

Ph: 416-808-4877

“Committed to Lifelong Learning”

